

User manual and Installation Guide

AHU-400 BR



User manual. Page 1 to 9



To open the front hatch you will find a key for the quarter turn latches in the folder together with the following documents.

Keep this key in a place so it is out of reach for children.

To open the latches turn the key a quarter towards the center of the unit.

Left latch



Right latch



To close, after putting the hatch back on place, turn the latches the opposite way. You may use some pressure towards the hatch to close it.



The appliance is not to be used by children or persons with reduced physical, sensory or mental capabilities, or lack of experience and knowledge, unless they have been given supervision or instruction.

Children should be supervised not to play with the appliance.

Before access to electrical connection boxes the electrical power has to be disconnected.

Only authorized persons are allowed to enter the electrical junction boxes.

If electrical components are damaged, it must be replaced by the manufacturer, retailer or similarly qualified persons in order to avoid dangerous situations.

If the supply cord is damaged, it must be replaced by the manufacturer, its service agent or similarly qualified persons in order to avoid a hazard.

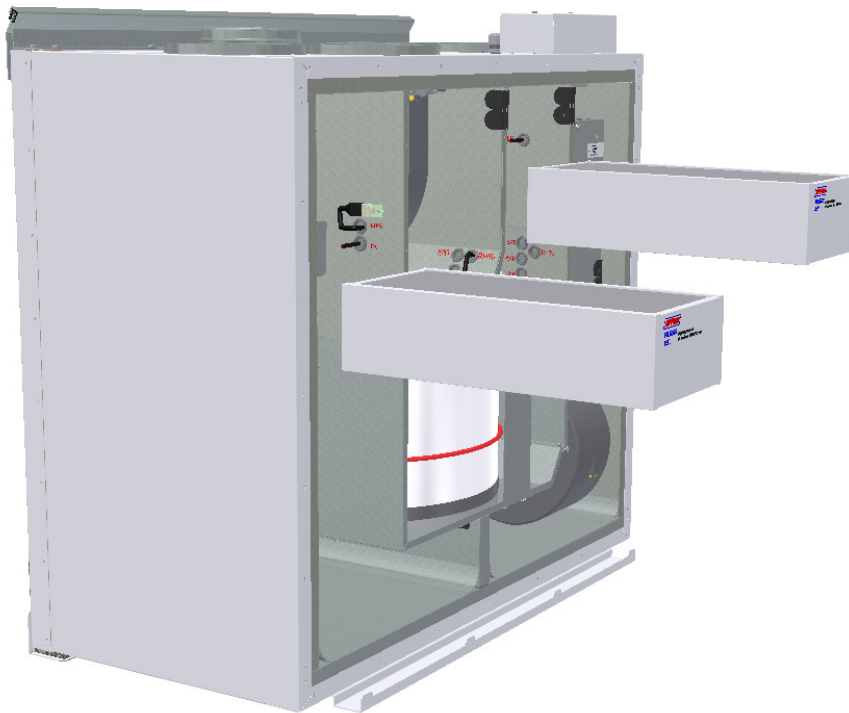

Replacing the filter.

Should be extracted without the use of tools.

If the filters are "healed" fixed so it can help to remove the rotating exchanger block first.

Replacing the filter must be carried out by the manufacturer, its service agent or similarly qualified persons only

New filters can be ordered on art no: 270272-2



Cleaning the fans.

Cleaning the appliances must be carried out by the manufacturer, its service agent or similarly qualified persons only.

Disconnect the 3-pole and 5-pole plugs.

Extract the fans without help of any tools.

To get out the fan for exhaust air you first have to remove the bracket. It is important to set the bracket back in place after cleaning the fan.

Clean with mild soap and water.



Maintenance and cleaning of rotary heat exchanger

Cleaning the appliances must be carried out by the manufacturer, its service agent or similarly qualified persons only.

Disconnect from the corresponding 3-pole plug and unplug.

Should be extracted without the use of tools.

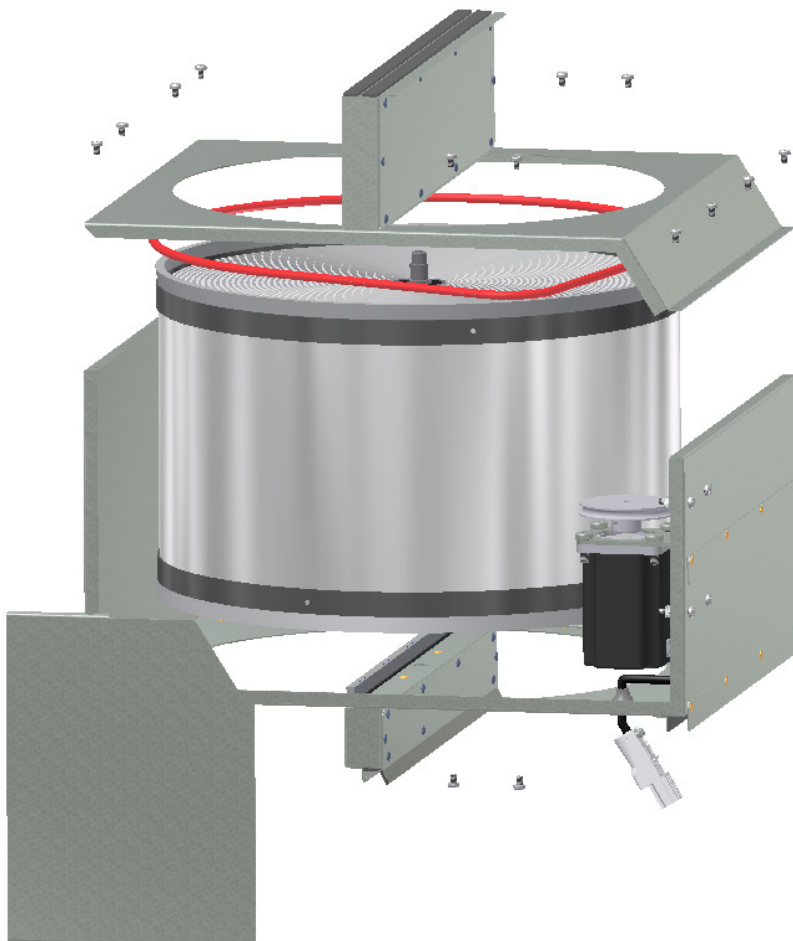

Rotor exchanger can easily be removed for cleaning by dissolving the 14 screws that hold it together.

Clean with mild soap and water. When assembling again.

Ensure that the screws are tightened sufficiently so that they do not come loose during operation.

Overview of control panel

The main screen consists of, from top, left:

1. Time Indication, hour, minute
2. Timer (if programmed)
3. Reheating coil (if connected)
4. Temperature readings, Outdoor / Indoor
5. Status airflow – fan speed setting (shows inlet) 3 + level of
6. Max timer - up to 4 hours
7. Temperature set-point, 15 - 21 °C
8. Reheating coil - on / off
9. Rotor indicator

Indicators in the menu screen:



"Sun" indicates that the rotor has stopped, the air handling unit is in the summer operation mode



"Snowflake" low temperature indicates that the airhandling unit is in defrosting mode.

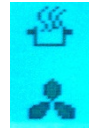

"Steaming pot" indicates that the kitchen exhaust is activated.



"Timer" and the countdown of the fan symbol indicate that the fan acceleration is enabled.



"Away" indicates when the feature is enabled, this feature will override timer.



"Clock over the fan symbol" indicates that the timer is activated.

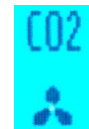

Co2 over the fan symbol" indicates that the carbon sensor is activated.



"Exclamation point" indicates that moisture recorded over the sensor is higher than the set value.

Main Menu

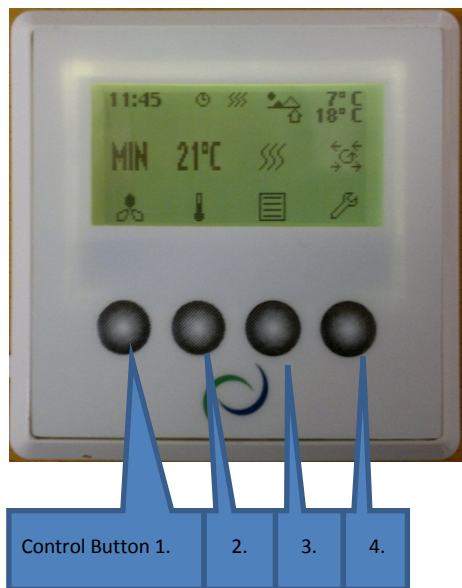

Operation buttons

- 1. Control Button indicator for fan
- 2. Control Button indicator set point.
- 3. Control Button indicator information.
- 4. Control Button indicator settings.

1.

Ventilation unit has three options for choice of airflow, Min, Normal and Max. For programming of values within each step, see 4.5.1.3 Using the control button 1, and - / + buttons can change between the pre-programmed selections

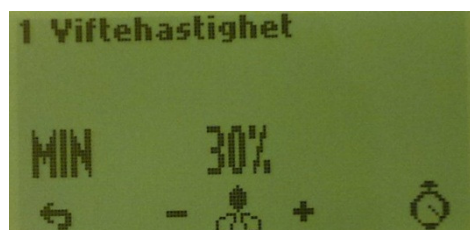

1.1

Forced fan, fan speed increases to max speed. Interval adjustable from 10 - 240 min. The function is for use if high humidity in bathrooms and laundry room. This feature can also be operated via an external pulse switch. The switch is placed in the bathroom or adjacent rooms. (D1 on the mainboard in the unit) for the activation of fan forced use control button 4



2.

Choose from pre-programmed temperature settings-set point between 15 - 21 °C setting is changed by operating the switch buttons below - / + symbols.



Indicator for activated heat unit

Reheating element is connected in / out by operating the switch button 4 (if this is enabled, see 4.5.1.1).

3. Main Menu for information.

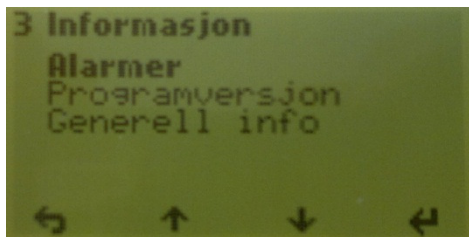

3.1

When alarm you can find a source of error here, as well as info on how the alarm is reset.

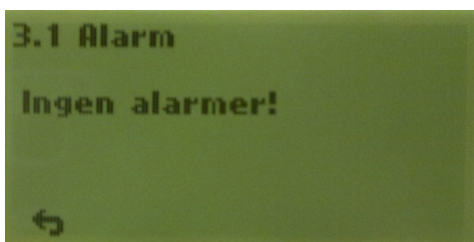

3.2

Information about the current software version

This information is provided to service personnel at the failure of the unit.

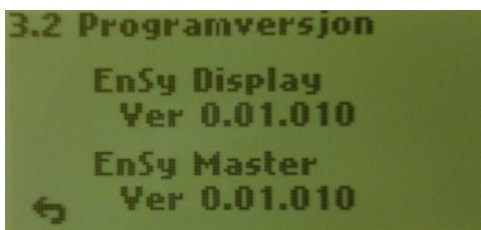

3.3

Under the menu general info you will find what defrost mode is selected, see 4.5.1.9 choice of settings. Which display is defined as the main display appears here if the plant has mounted numerous single one. See 4.5.1.10 selection of the main display.

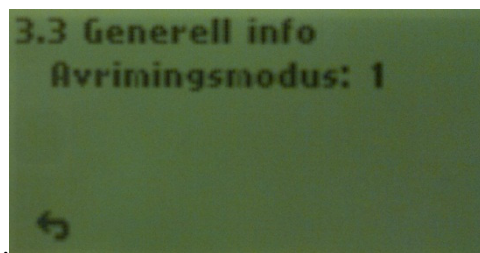

4.

Main menu settings

To navigate within the various sub-menus when using the control buttons below the up / down cursor key that displays on the display



4.1

Setting Menu for time and date. This setting is important since the information forming the basis for the calendar function with the timer and timer to be activated.

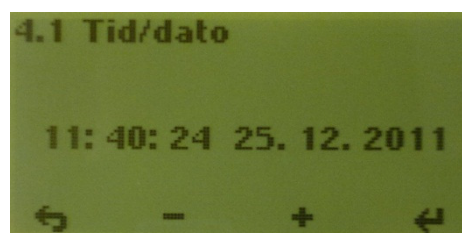

4.2

Programming the timer, fan speed and temperature set point. Here can be programmed for two periods each day. Ex. day - night.

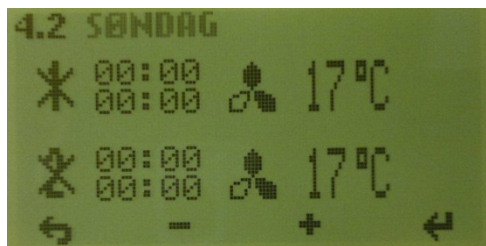

Every day must be programmed individually. Sunday - a period of time, select the start time. Activation of the period, X - over period the number is removed, use the - / + keys.

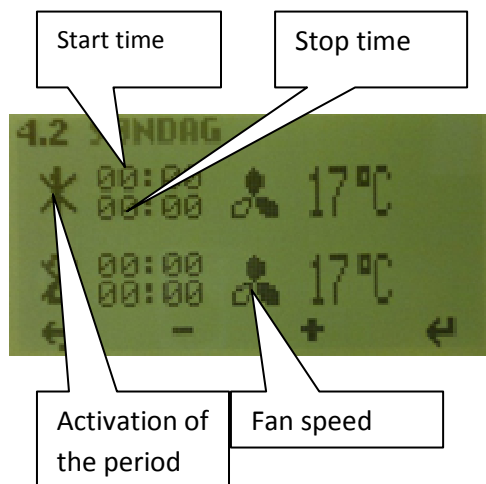

Choose airflow (fan speed) Speed dialing - Min when one fan blade on the indicator is black. Normal speed = two black fan blades on the indicator. Max speed = three black fan blades on the indicator.

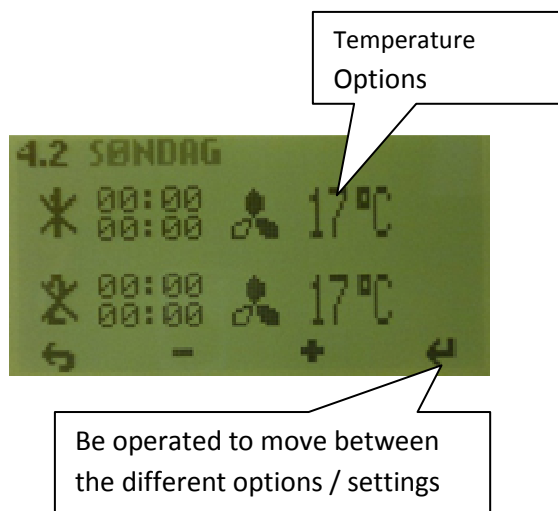

Select the desired supply air temperature you want during the period. Settings between 15 - 21 °C

4.3

Setting the time interval for filter change. Current choices are 6, 9 or 12 months. Make your choices by using the cursor keys + / -. Alarm reset elapsed period by pressing the menu button in the "Filter OK"

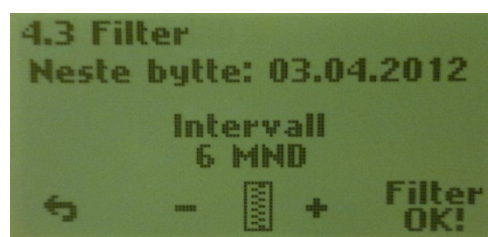

4.4

Adjusting the contrast and color on the display

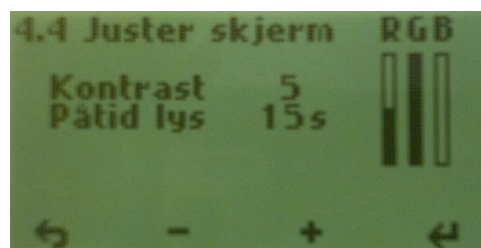

4.5

Configuration / Settings:

To proceed, use code 1000

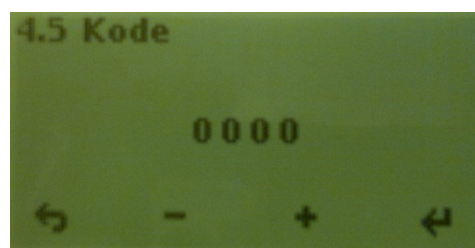

4.5.1

Menu for selection of a parameter you want to change settings on.

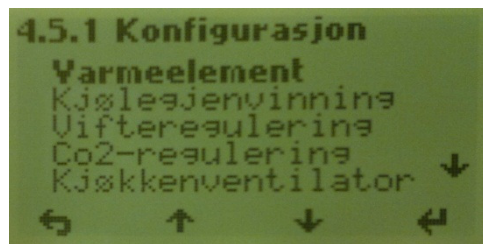

4.5.1.1

Turning on/off the reheating coil, use the minus or plus button to change settings.

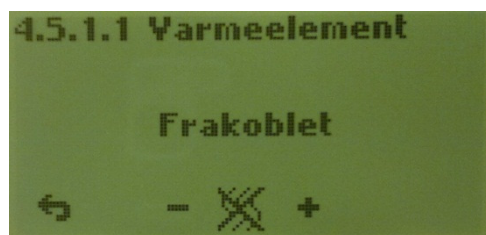

4.5.1.2

Activation of the cooling recovery:

It is pre-programmed two options for use when the outside temperature is higher than the indoor temperature, heat recovery system will activate the function start and supply air will be cooled by exhaust air. Engagement when the outdoor temperature is 2 °C or 3 °C higher than room temperature.

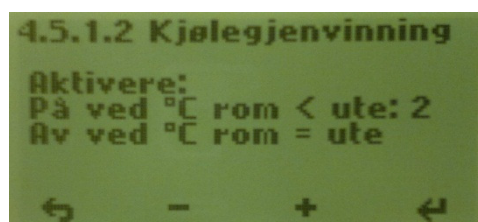

4.5.1.3

Settings from factory.

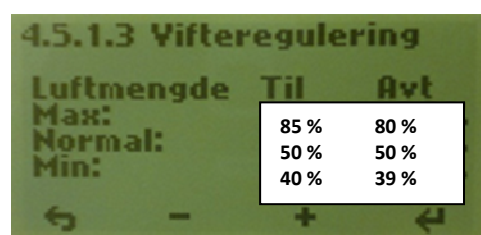

4.5.1.4

(If the facility is connected)

Menu for enabling / disabling of CO2 control.

Here you pre-programming current ppm values and forcing speed fans.

NB! For balanced ventilation it is essential that the exhaust and inlet fan has the same value.

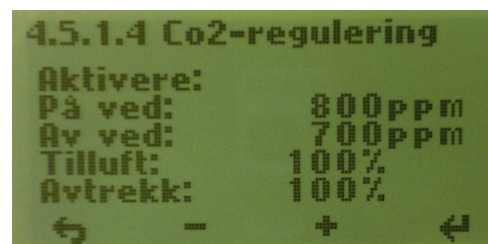

4.5.1.5

Menu for setting the fan speeds on the facility are connected to the kitchen hood.



4.5.1.6

If the plant has connected Humidity Sensor / Motion Sensor (D2 connected to the input on the main card)

Menu for setting the acceleration fan speed. Select the airflow fans will grow to at the signal from these sensors

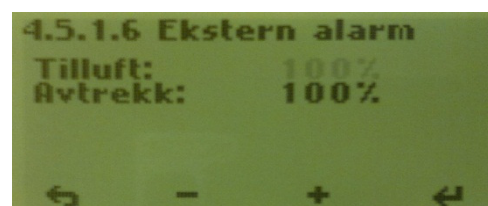

4.5.1.7

Menu for setting the desired values by activating away / home function.

The function is operated via an external switch (connected to the output D3 on the main board)

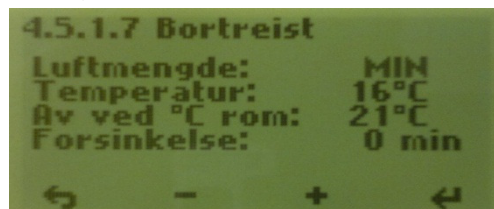

4.5.1.10

When using two displays must be from this menu to define the display is the primary display, "select display 1 or display 2»

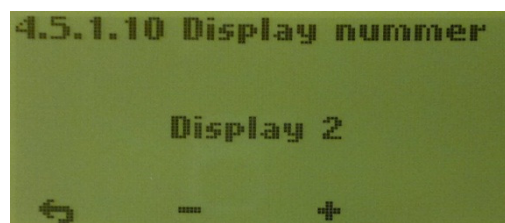

4.5.1.8

Menu for calibration of the built-in temperature sensors.

NB! These are supplied calibrated from the manufacturer.

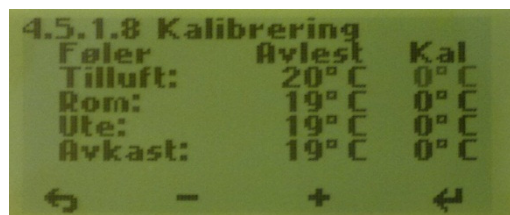

4.5.1.9

Menu for changing the defrost mode at low temperatures.

Mode 1: at low humidity

Mode 2: normal humidity

Mode 3: at high humidity

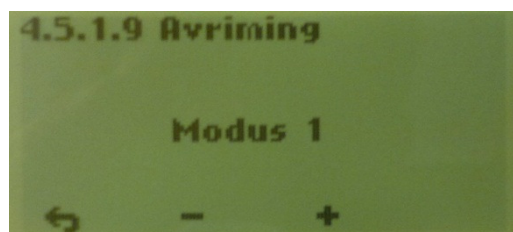

Installation guide. Page 10 to 20.

Table of Contents

1. General
2. Mounting
 - 2.1 Brackets and vibration gasket
 - 2.2 Stoppers
 - 2.3 Duct covers
3. Connections
 - 3.1 Electrical connections
 - 3.2 Duct connections
4. Commissioning

1. General

This guide is designed to provide installation and user instructions regarding the correct installation of AHU 400

AHU 400 is designed for heat recovery with air volumes of up to 400 m³ / h. The energy from the exhaust air is transferred to supply air through the rotary heat exchanger where the air streams pass each other without making contact.

The unit has a built in-heater for supplementary heating of supply air. The unit can also connect additional equipment cooker hood over the stove, pulse switch for controlling the forced ventilation, for example, wet rooms or bathrooms, sensor for carbon management and switch management away / home function. Control of peripheral equipment is integrated in AHU 400

Humidity sensor for forced ventilation is integrated into ventilation unit.

AHU 400 is supplied in painted finish, tested and ready for operation. Installation, commissioning and tuning must be performed by authorized personnel.

2. Mounting

Together with the unit is delivered the following equipment:

1. Suspension bracket
2. Wall Bracket with vibration dampening gasket
3. Self-adhesive vibration damping
4. Stoppers
5. Accessories bag containing the necessary screwsKey to open the hatch

First select how the unit should be mounted so that the air tube connection should be as easy as possible.

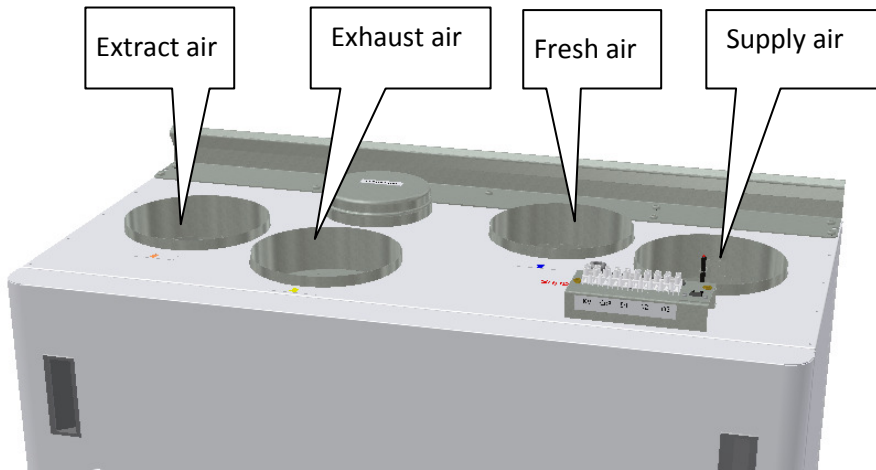

2.1 Brackets and vibration gasket

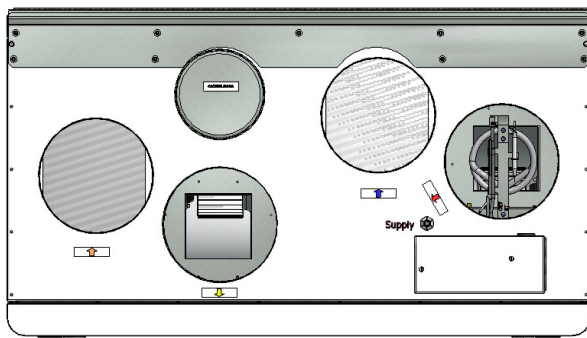

Suspension bracket screwed on top of the unit as shown.



Use 9 pcs M5 x 16mm, supplied with the unit.

Make sure that the edge protection gasket is placed on the wall bracket.

To get the unit in right position use the following brackets and screws. In order to relief the hanger bracket on the top it is important however also to mount the bracket to be under the unit. Ensure that the screws hit the beams behind the wall if the unit is to be hung on a light wall.

Use 6 pcs wood screws 5 x 40mm, supplied with the unit, for each bracket.

Mount the wall bracket with vibration gasket, ensure that the vibration gasket is intact.

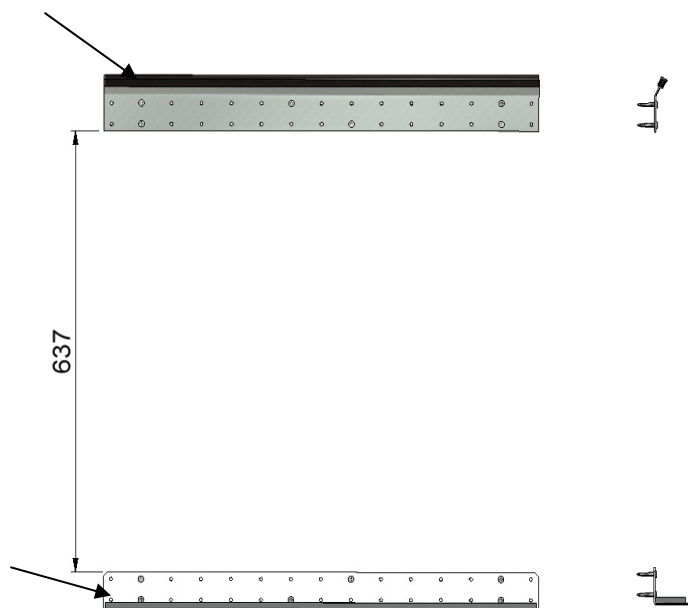

Glue vibration gasket to the back of the unit, see illustration.

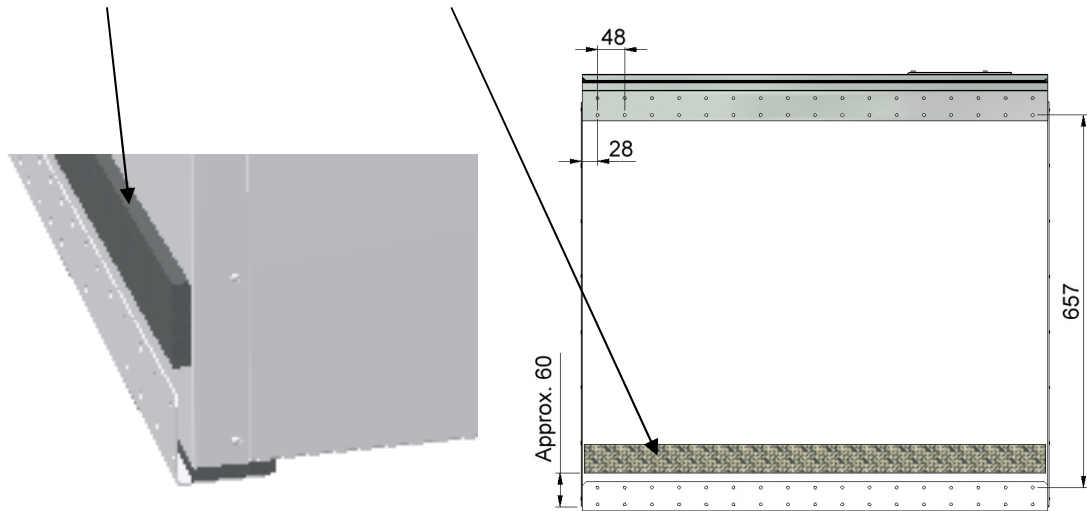

Lift the unit in place and ensure that there is no direct contact between the unit and building construction.

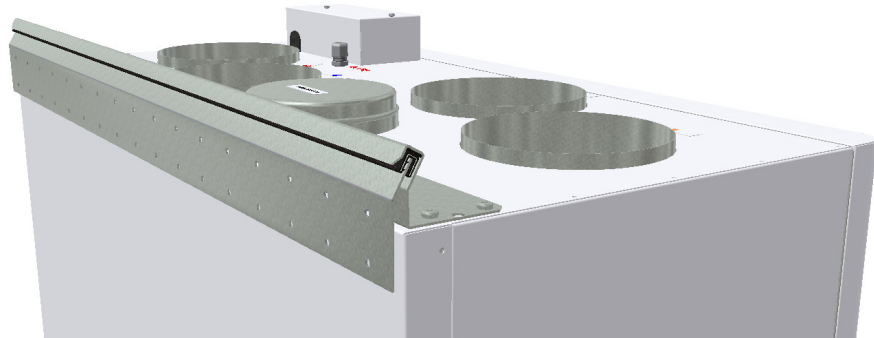

2.2 Stoppers

To prevent the unit to be lifted out of the brackets should be installed two stoppers. Use 2 pcs wood screws 5 x 40mm, supplied with the unit, for each bracket. In order not to transmit vibration it is glued vibration material on these brackets.

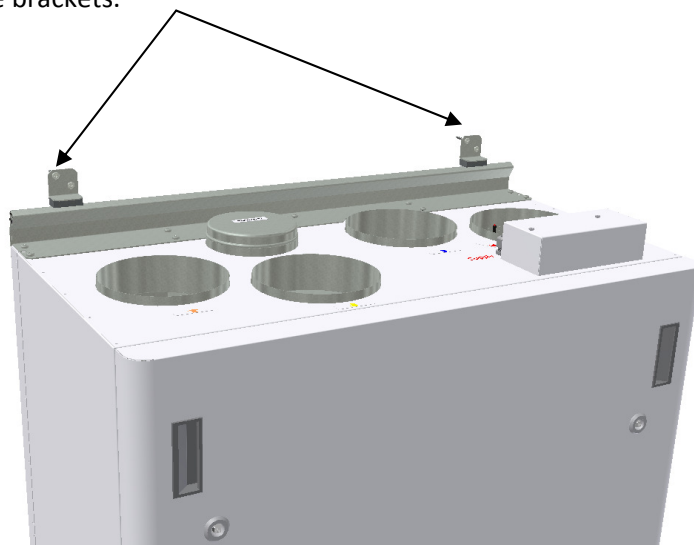

The unit can also be placed on the floor. It is then important that there are placed at least 50 mm

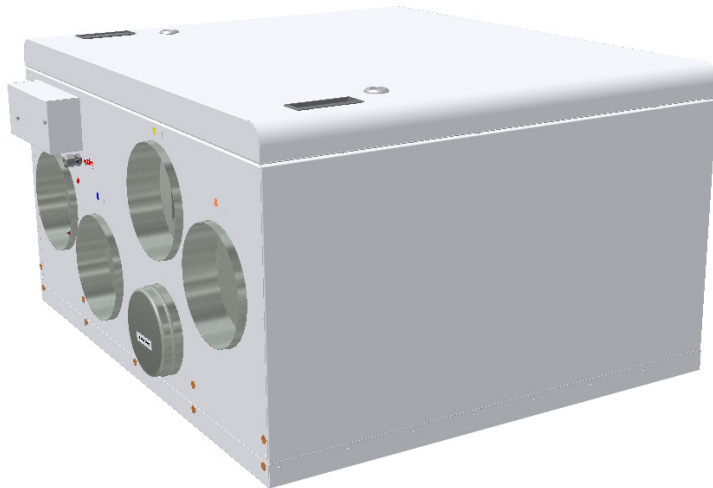

insulation under the unit to prevent vibration to the building. If ventilation unit will be placed as the sketch shows it must not be covered so that service is prevented.

If placed at the attic make sure that there are at least 600 mm clearance over the front hatch so there will be room for service.

2.3 Duct cover

If you want to use a duct cover to hide the ducts you will need the distance 296 mm from the roof and down to the top of unit. The duct cover must be ordered separately. (Art: 0100307-2) The instruction how to mount this duct cover you will find together with the duct cover.

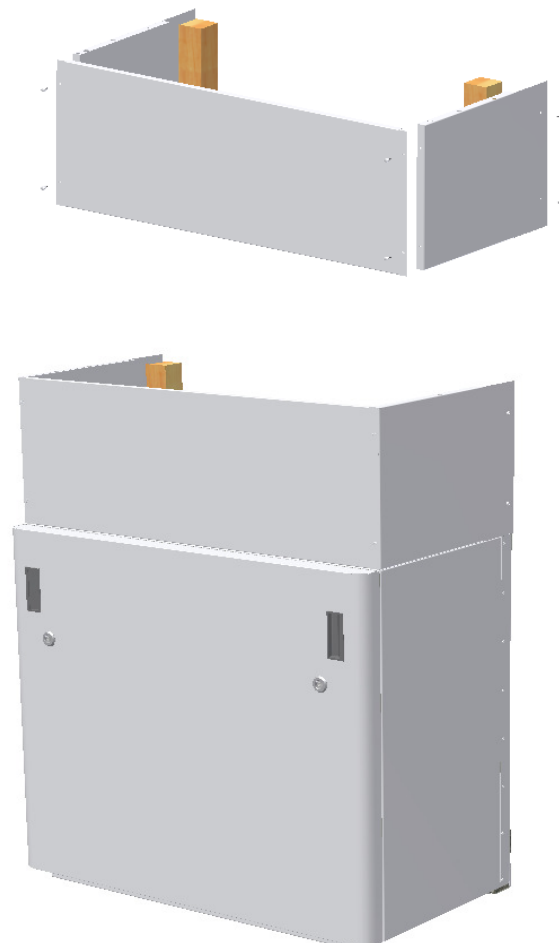
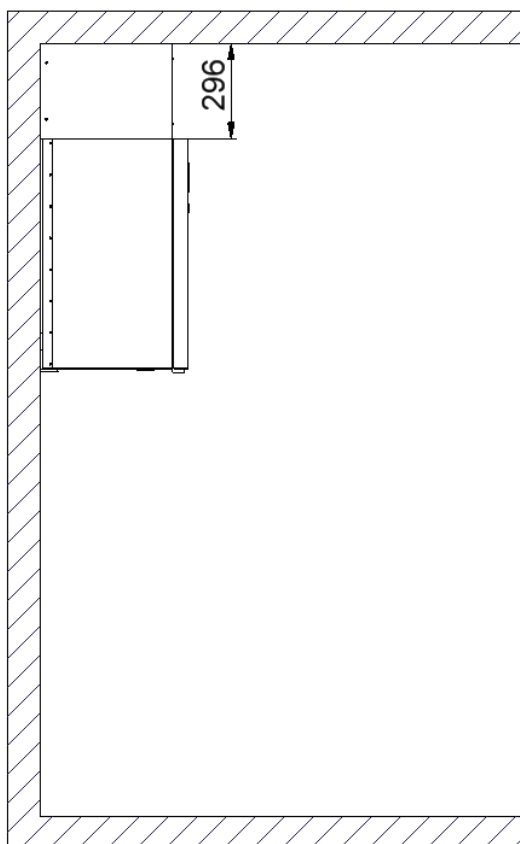

DIMENSIONS

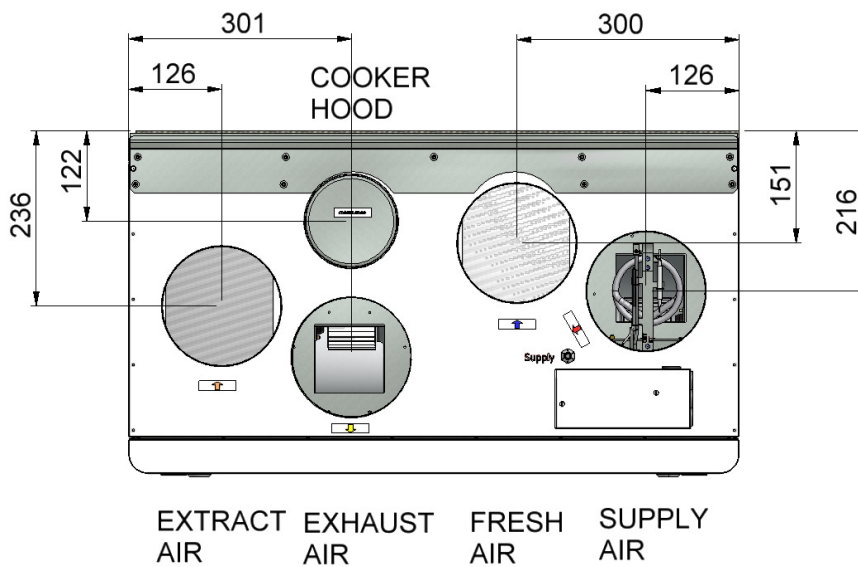
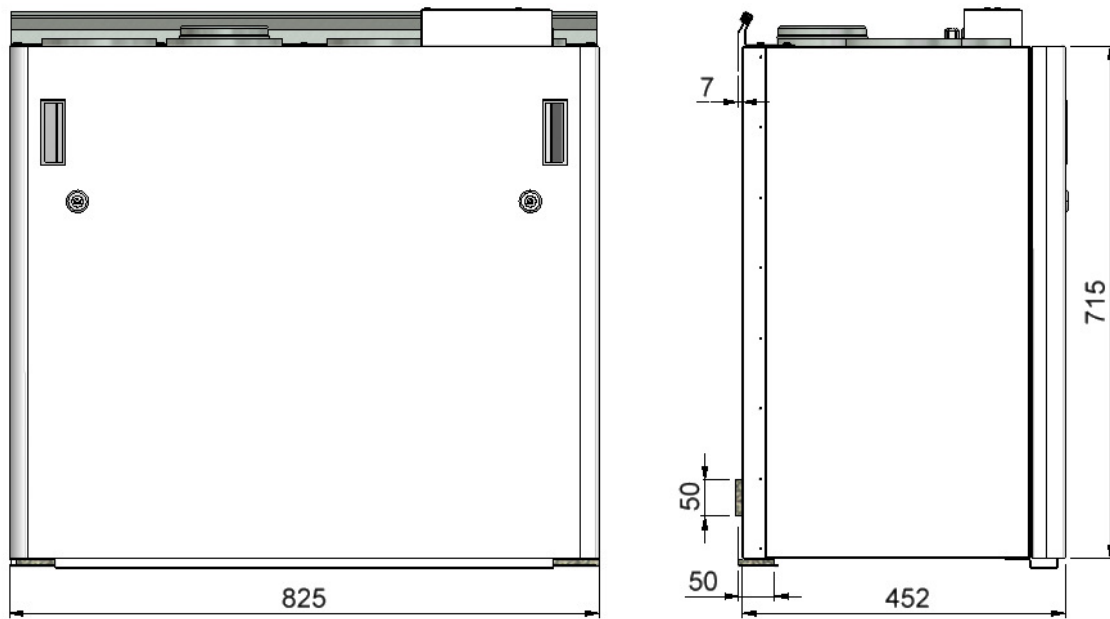

All ducts are $\varnothing 160$ mm except the duct for cooker hood that is $\varnothing 125$ mm.

TECHNICAL DATA

Reheating unit + fans	-phase/voltage	(50Hz/VAC)	~1 / 230
	- power consumption	(W)	1540
Automation System			Integrated
Filter Class	Superpleat		F7
Thermal/sound insulation	(mm)		40
Weight	(kg)		64,5

SPECIFICATIONS

- Rotary heat exchanger with heat recovery up to 85% efficiency.
- Electric heating coil.
- High efficiency and low noise EC fans. Adjustable 30 to 100 % speed.
- Adjustable supply air temperature up to 21 ° C.
- Acoustic and thermal-insulated housing.
- Integrated control system with "Touch Panel" for the control of the unit supplied as standard.
- The unit is designed for optional connection of a cooker hood in top of the unit.
- Output for connection to Co² sensor.

ATTACHEMENT:

Duct Cover for the encapsulation of tubes in the top. (Art: 0100307-2)

Kitchen exhaust hood

Extra control panel, desire more control points. (0100051-2)

Co² sensor for room installation

Replacement filter F7. (Art: 270272-2)

Replacement fan. (Art: 01001020-2)

Demand controlled ventilation - adequate air quality

<p>Control Panel:</p> <p>Placed at a suitable place in the building to do the monitoring and regulation of ventilation as simple as possible. Must not be placed in bathrooms or wet area. The controller shall be mounted on the wall.</p>	<p>Motion Detector:</p> <p>When installed in a living room, this will give the signal to the unit to increase speed to max airflow.</p>	<p>Humidity sensor:</p> <p>Humidity sensor for forced ventilation is integrated into ventilation unit.</p>	<p>CO² sensor:</p> <p>Can be installed in the living room, will signal to the unit on the pollution level in the room. Ventilation governed by needs.</p>
--	--	---	---

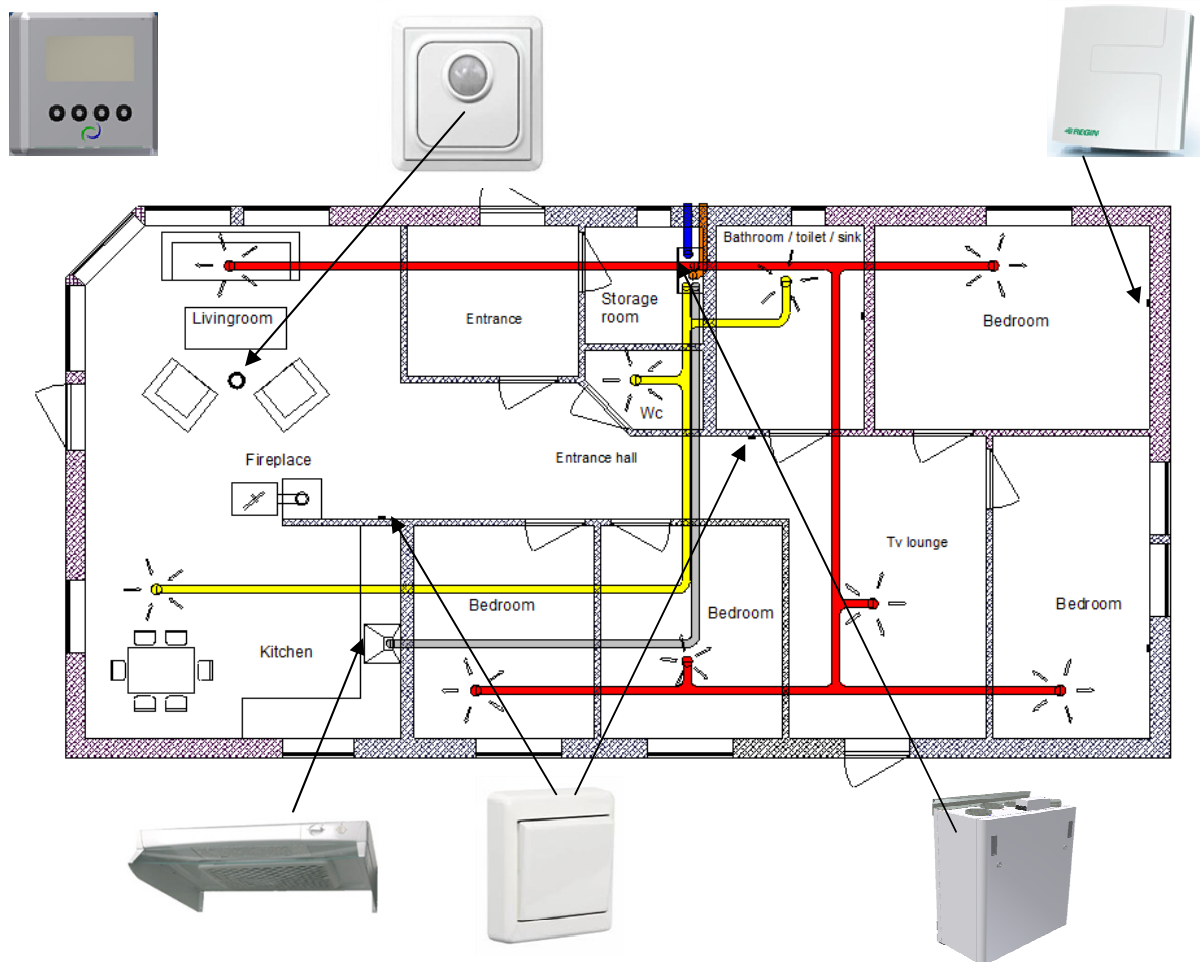

<p>The unit is designed for connection of external kitchen hood.</p> <p>This is an alternative solution for problems with returns through the wall.</p>	<p>Stove / Fireplace / Bathroom</p> <p>Wireless control panel / pulse switch can be used to increase supply by use of a stove.</p> <p>Mounted in a suitable location in relation to the unit. Can also be placed near the bathroom for easy operation by forced ventilation (max airflow)</p>	<p>Air handling units should be located in suitable rooms in central residence (utility / laundry room) to ensure easy access for service and filter change.</p> <p>Not allowed to be placed in bathroom.</p>
---	---	---

3. Connections

3.1 Electrical connections

AHU- 400 is supplied with approximately 1.7 m cable and plug for 10A / 230V outlet.

Remote control panel complete with cable, length 10 meters.

Connections of sensors / external functions see the following wiring diagram for details.

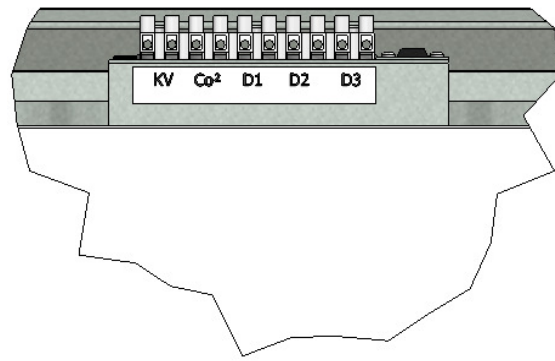

3.2 Duct connections

The unit is mounted preferably in example. Laundry room, storage room, utility room, etc. Air duct from cooker hood can be connected to separate "bypass channel" in the top of the unit.

The unit is designed to hang on the wall or lying on the "back". Remember, if lying on back then it requires extra 50mm vibration damping to the surface.

The choice of placement must be taken into account that the unit requires periodic maintenance. Ensure that it is possible to open / remove the unit inspection hatch, and that there is sufficient room to remove the main components. If the unit is mounted on the lightweight wall construction to the living room, for example bedroom / living room, recommended wall insulated / constructed so that the risk of sound transmission avoided.

Fresh air intake is placed primarily on the building's north and east and at a good distance from the exhaust openings for ventilation, central vacuum, Hoods and Vents, sewer vent, chimney or other contaminated source such as dust / exhaust from traffic etc. The return of the exhaust air should always be in good distance from fresh air intakes, close windows, etc.

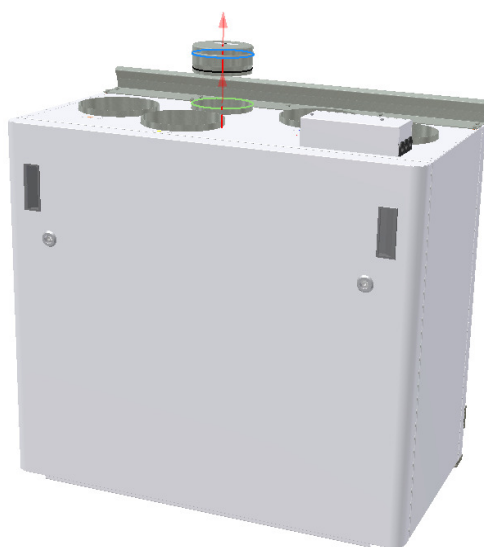

If kitchen exhaust hood is to be used together with the unit

When connecting the kitchen exhaust hood to the top of unit.

If kitchen exhaust hood is to be connected into the top of the unit you must remove the end cap in the top that is marked COOKER HOOD

Sketch for mounting cooker hood to the top of the unit.

1. Supply air bedroom
2. Supply air living area
3. Extract kitchen
4. Extract bathroom / utility room
5. Ventilation unit
6. Roof cowl/ exhaust air
7. Fresh air / outdoor air inlet
8. Cooker hood

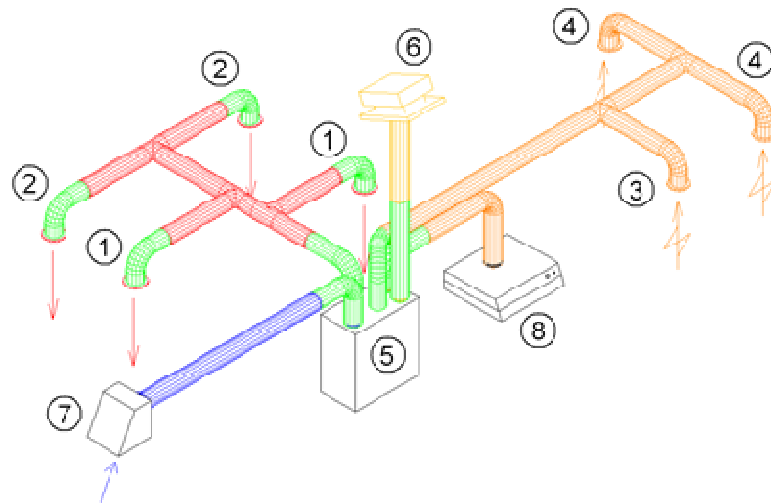

Air to and from the unit will be led through the ducts. Good durability and cleaning capabilities are achieved by using ducts in galvanized steel.

Short customizations (à 1 m length) with a flexible aluminum -ducts can be used for wiring between the unit and roof cowl / wall grid.

In order to achieve effective, low energy consumption and proper air flow, the duct system designed with low air speeds and low pressure drop.

NB!

- ☐ If the cooker hood is not connected, the end cap must not be remove.
- ☐ Tumble dryer must not be connected to the ventilation unit, but have its own duct to the open air.
- ☐ Duct should be kept covered during storage and installation.
- ☐ Location of the exhaust grid / roof cowl must also meet current building conditions, as well as any requirements of local building authorities.
- ☐ All inlet and outlet of the unit must be connected to the piping.

Pairing of duct sections.

All joints between ducts, T-pipes, bends, reducers, etc. have to be "locked" by using special tape or at least 3 pieces of self-tapping screws.

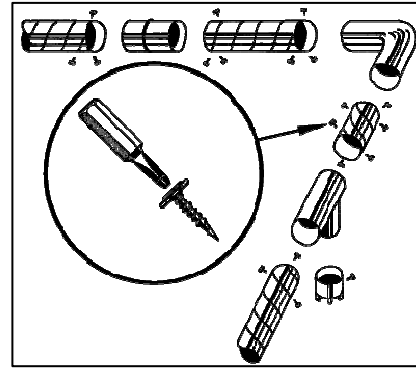

Sound reduction

To avoid disturbing noise from blowers in living area installation of sound-absorber (silencer) in the duct for supply and extract air recommended. (length = 0.9 meters each section)

To prevent sound transmission between rooms via the duct system, and reduce any noise that occurs in the duct system, is also recommended a silencer in front of each supply diffuser in the living area.

Flexible ducts.

Flexible ducts can be used for adjustments between the unit and roof cowl / fresh air inlet. Alternatively, the flexible silencers used (remember requirements for outdoor sound level).

Condensation/isolation

Fresh air and exhaust duct should always be condensation insulated throughout its length. Proper performance of the unit connection is especially important. Similarly, isolate all other ducts for cold and uninsulated room. Use insulation stockings (50 mm mineral wool) with a vapour barrier of plastic that is pulled over the duct. For installation in districts with particularly low winter temperatures, the ducts always must be isolated. The total insulation thickness must be at least 100 mm.

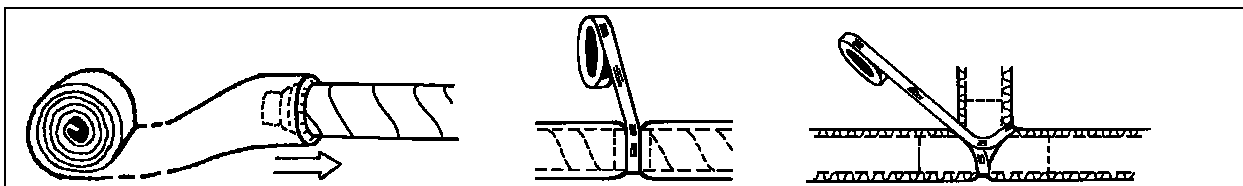

NB! Remember, good overlap of diffusion and taping in joints.

Inlet diffusers, extract louvers and cooker hood

Supply air diffusers have to be placed in the living area such as bedroom and living room, while the exhaust air louvers are placed in wet areas (bathrooms, laundry, etc.), toilet and kitchen.

Note: Although the cooker hood connected to the unit it also must be mounted separate exhaust louver in the kitchen.

The AHU 400 cooker hood outlet is led directly to the exhaust fan without the smell and pollutants carried through the heat exchanger. In order to achieve heat recovery from ventilation due to

exhaust louver in the kitchen, therefore, this exhaust louver has to be connected together with the exhaust from the wet cells.

NB! Cooker hood must be equipped with dampers which are dense in the closed position (without opening for the basic ventilation)! Blind cap provided with cooker hoods custom unit.

Exhaust air louvers can be mounted in the ceiling or wall. Supply air diffuser can be mounted in the ceiling or "low wall". In "low wall" must sectorial aperture positioned so that supply airstream carried upwards along the sloping ceiling. Supply in the wall at the horizontal ceiling must have "throwing direction", so that air enters the room along the ceiling. Air supply via the outlet valve allows air jet throw length, and the exhaust air diffusers can therefore be used as supply air diffuser in the wall when there is ridge ceiling.

The diffusers should be mounted in frames, so that they can be easily removed for cleaning.

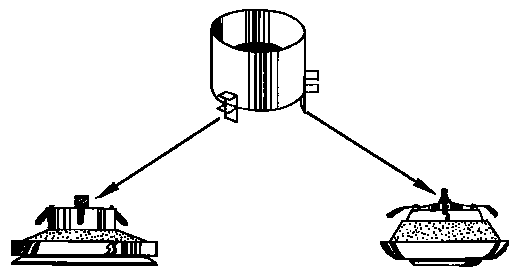

4. Commissioning

Setting of the airflow.

As default setting may supply air diffusers core is opened from 5 to 7 turns from the closed position and locked with a centre nut. Exhaust louvers core is opened 10 turns from the closed position and locked with a centre nut. For adjustment of air flow to each room the settings for the diffusers must be measured. Balancing scheme (diagram) intended by design, or alternatively by balancing acc. flow measurements with equipment specifically designed for this.

Supply air diffusor

Exhaust louver

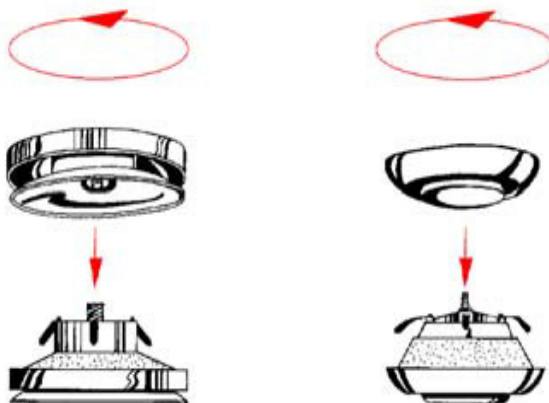



Ensy AS
Vågsmarka 9
N-5680Tysnes
Tel: +47 415 72 950